

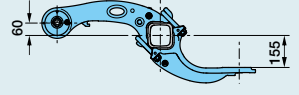
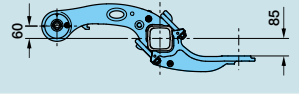

ECO Air COMPACT – Standard series with disc brake TSB 4309 / TSB 3709

9-t-ECO Plus bearing / offset 120 mm

Air suspension

ride height (empty without air)	hanger bracket height	versions
145 - 175 mm	ST = 205 mm	ACAU hooked H = 60 mm / cranked K = 155 mm 
185 - 215 mm		ACAM hooked H = 60 mm / cranked K = 85 mm 
240 mm		ACBM hooked H = 130 mm / cranked K = 85 mm 
270 - 300 mm		ACBO hooked H = 130 mm / cranked K = -10 mm 
330 - 390 mm	ST = 290 mm	

1 Air bag

not mounted or mounted

type	offset
30 / 30K	V = 20 mm
30 / 30K	V = 0 / 20 / 60 mm
36 / 36K	V = 80 mm
36	V = 45 / 80 mm
36-1	V = 45 / 80 mm

2 ABS

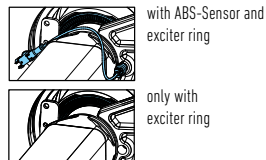

3 Air bag beam [U / M / O]

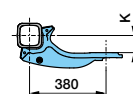

type	cranked	BPW-No.
U	K = 155 mm	03.244.20.02.0
M	K = 85 mm	03.244.20.03.0
O	K = -10 mm	03.244.20.04.0

4 Trailing arm [A / B]

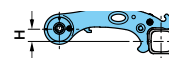

type	hooked	BPW-No.
A	H = 60 mm	03.244.20.01.0
B	H = 130 mm	03.244.20.05.0

5 Hanger bracket height [ST]

not mounted or mounted

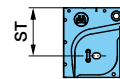

ST	BPW-No.
205 mm	05.375.50.01.0
290 mm	05.375.50.02.0

6 Axle beam

square 120 x 10 mm



7 Wheel bolt



BPW-No.
03.296.33.21.1

8 Brake cylinder

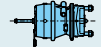
not mounted: every technical approved type
mounted: only these types

M/M	M
	
16 / 24 "	16 "
20 / 24 "	18 "
only for TSB 4309 {	20 "
	22 "
	24 "

9 Shock absorber

not mounted or mounted

L min. / L max.	BPW-No.
287 / 412 mm	02.3722.79.02
292 / 432 mm	02.3722.89.02
326 / 496 mm	02.3722.83.02
351 / 541 mm	02.3722.88.02

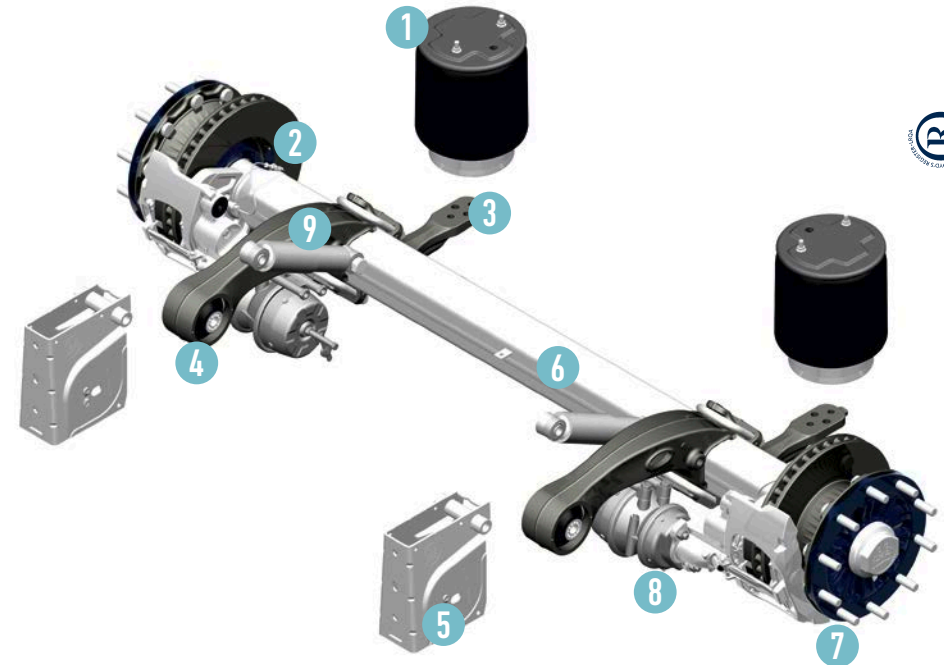

Track / Spring centre

TSB 4309	
Track [SP]	Spring centre [FM]
1980 mm	1250 / 1270 mm
2010 mm	1300 mm
2040 mm	1200 / 1250 / 1300 mm
2095 mm	1300 mm
2140 mm	1300 / 1400 mm
TSB 3709	
Track [SP]	Spring centre [FM]
1965 mm	1200 / 1270 mm
2010 mm	1200 / 1300 mm
2040 mm	1200 / 1300 mm

Two-sided lifting device (not mounted)

05.828.32.05.0 (hooked H = 60 mm)
05.828.32.06.0 (hooked H = 130 mm)



One-sided lifting device (not mounted)

05.828.32.07.0

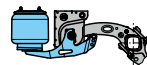

Disc protector

not mounted or mounted



Wheel nuts

not mounted



Special equipment which is not mentioned here cannot be added to the range of delivery of EAC (e.g. preparation tyre pressure control system).